

## Paper 3 Preparation Paper

Edexcel  
Higher



Corbettmaths

This is a collection of questions broadly covers the specification.

The topics highlighted in green (and bold) are topics from the Unseen Topic Checklist

### Guidance

1. Check your answers seem right.
2. Always show your workings
3. Take your time when working through this collection of questions

Revision for this test

[www.corbettmaths.com/contents](http://www.corbettmaths.com/contents)



Question	Topic	Video number
1	<b>Best Buys</b>	<b>210</b>
2	<b>Scatter Graphs</b>	<b>165, 166</b>
3	Standard Form	300, 301, 302, 303
4	<b>Conversion Graphs</b>	<b>151, 152</b>
5	<b>Constructions</b>	<b>72, 78, 79, 80, 70</b>
6	<b>Loci</b>	<b>75, 76, 77</b>
7	<b>Area of a Trapezium</b>	<b>48</b>
8	<b>Volume of a Cylinder</b>	<b>357</b>
9	Volume of a Prism	356
10	<b>Stem and Leaf</b>	<b>169, 170</b>
11	<b>Two way Tables</b>	<b>319</b>
12	<b>Pie Charts</b>	<b>163, 164</b>
13	<b>Frequency Polygons</b>	<b>155, 156</b>
14	LCM/HCF	218, 219
15	Laws of Indices	174
16	Product Rule for Counting	383
17	<b>Substitution</b>	<b>20</b>
18	Changing the Subject	7, 8
19	Drawing Linear Graphs	186
20	<b>Simultaneous Equations</b>	<b>295</b>
21	<b>Currency</b>	<b>214a</b>
22	<b>Percentages</b>	<b>233, 235</b>
23	Ratio	270, 271
24	<b>Compound Interest</b>	<b>236</b>
25	Error Intervals	377
26	<b>Angles: Parallel Lines</b>	<b>25</b>
27	<b>Bearings</b>	<b>26, 27</b>
28	<b>Angles: Polygons</b>	<b>32</b>
29	<b>Circumference</b>	<b>60</b>
30	Fractional and Negative Indices	173, 175

Question	Topic	Video number
31	Reverse Percentages	240
32	Expanding 3 Brackets	15
33	Pythagoras	257, 259
34	Quadratic Graphs	264
35	Area of a Circle	40
36	Arc Length	58
37	Area of a Sector	48
38	Trigonometry	329, 330, 331
39	Translations	325
40	Rotations	275
41	Enlargements	104, 106, 107, 108
42	Reflections	272
43	Circle Theorems	64, 65, 66
44	Travel Graphs	171
45	Speed, Distance, Time	299
46	Density	384
47	Cumulative Frequency	153, 154
48	Estimated Mean	55
49	Tree Diagrams	252
50	Capture Recapture	391
51	Venn Diagrams	380
52	Histograms	157, 158, 159
53	Similar Shapes (Area/Volume)	293a, 293b
54	Limits of Accuracy	183, 184
55	Factorising	117
56	Factorising Quadratics	118, 119, 120
57	Solving Quadratics	266
58	Quadratic Formula	267
59	nth Term	288
60	Quadratic nth term	388

Question	Topic	Video number
61	<b>Equations</b>	<b>110, 113, 114, 115</b>
62	Inequalities	177, 178, 179
63	<b>Graphical Inequalities</b>	<b>182</b>
64	<b>Quadratic inequalities</b>	<b>378</b>
65	<b>Equation of a Circle</b>	<b>12</b>
66	Rates of Change	309a, 309b
67	Algebraic Fractions	21, 22, 23, 24
68	Functions	369, 370
69	<b>Trigonometric Graphs</b>	<b>338, 339</b>
70	<b>Transformations of Graphs</b>	<b>323</b>
71	Completing the Square	10, 371
72	<b>Iteration</b>	<b>373</b>
73	<b>Reciprocal Graph</b>	<b>346</b>
74	<b>Exponential Graph</b>	<b>345</b>
75	<b>Recurring Decimals to Fractions</b>	<b>96</b>
76	Surds	305 to 308
77	<b>Equation of a Tangent</b>	<b>372</b>
78	<b>Sine Rule/Cosine Rule</b>	<b>333</b>
79	<b>Pressure</b>	<b>385</b>
80	<b>Circle Theorems Proofs</b>	<b>66</b>
81	Proportion	254, 255
82	Parallel and Perpendicular Graphs	196, 197
83	Vectors	353
84	3D Pythagoras	259, 332
85	Volume of Cone/Pyramid/Sphere	359, 360, 361
86	<b>Conditional Probability</b>	<b>247</b>
87	<b>Congruent Triangles</b>	<b>67</b>
88	<b>Algebraic Proof</b>	<b>365</b>
89	Exact Trig Values	341
90	<b>Ratio - Problem Solving</b>	<b>270, 271</b>

Question	Topic	Video number
91	Geometric Proof	366
92	Area Under a Graph	389
93	Invariant Points	392
94	Simultaneous Equations (non-linear)	298

1. Two shops sell the same type of perfume.  
A 100ml bottle of perfume normally costs £40.

### Shop A

50% extra free



Only £40

### Shop B

Buy one get the second  
HALF PRICE

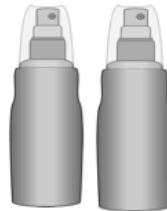

Normal price £40  
for 100ml

Rebecca says that both offers give the same value for money.  
Is she correct? Show your working.

(5)

2. The table below shows information about the monthly rent of an apartment and the distance of the apartment from a city centre, in miles.

Distance (miles)	3.2	1.5	5.7	8.2	0.7	0.9	4.4	5.8	9.3	0.4
Monthly rent (£)	340	420	250	190	500	470	300	260	170	510

(a) Plot the data on the scatter graph below.  
Clearly label your axes.

(3)

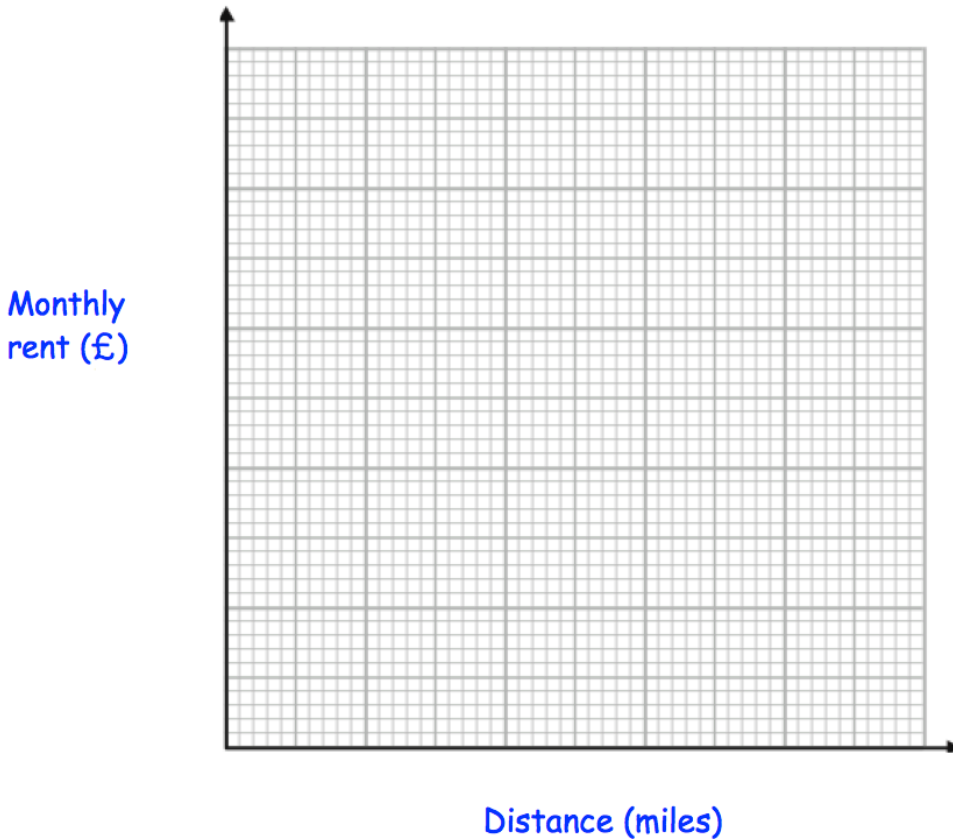

(b) Describe the relationship between the distance from the city centre and the monthly rent.

.....

.....

(1)

An apartment is 2.2 miles from the city centre.

(c) Find an estimate for the monthly rent

£.....

(2)

3. The population of England is  $5.301 \times 10^7$   
 The number of people who live in London is  $8.308 \times 10^6$

What percentage of the population of England live in London?

.....  
**(2)**

4.

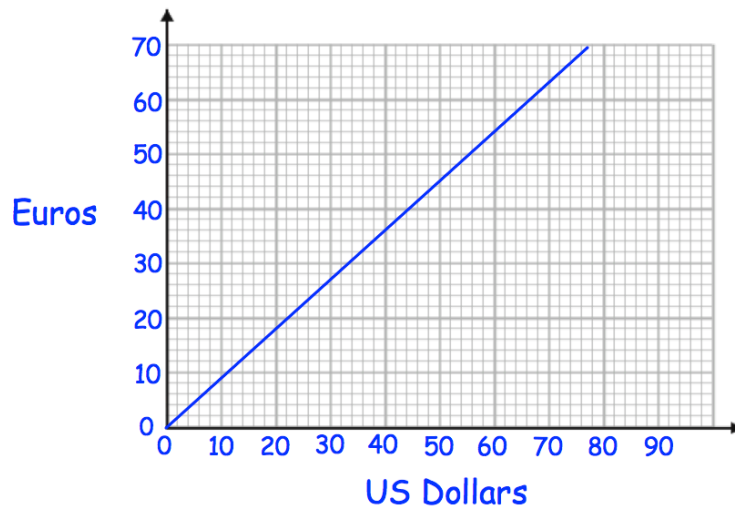
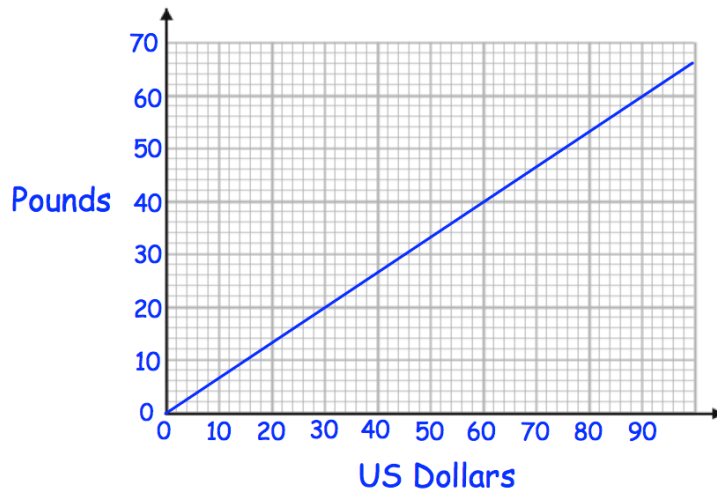

- (a) Change £30 into Euros.

.....Euros  
**(2)**

- (b) Change 200 Euros into Pounds (£)

£.....  
**(2)**

5. Use a ruler and compasses to construct the perpendicular to the line segment AB that passes through the point P.

You must show all construction lines.

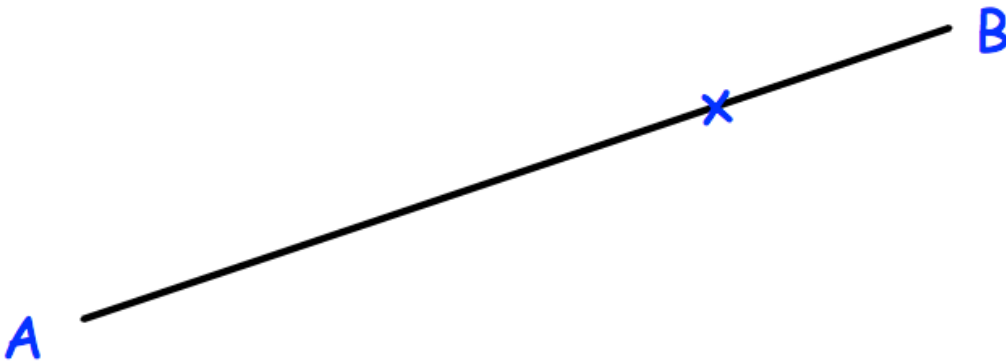



6.

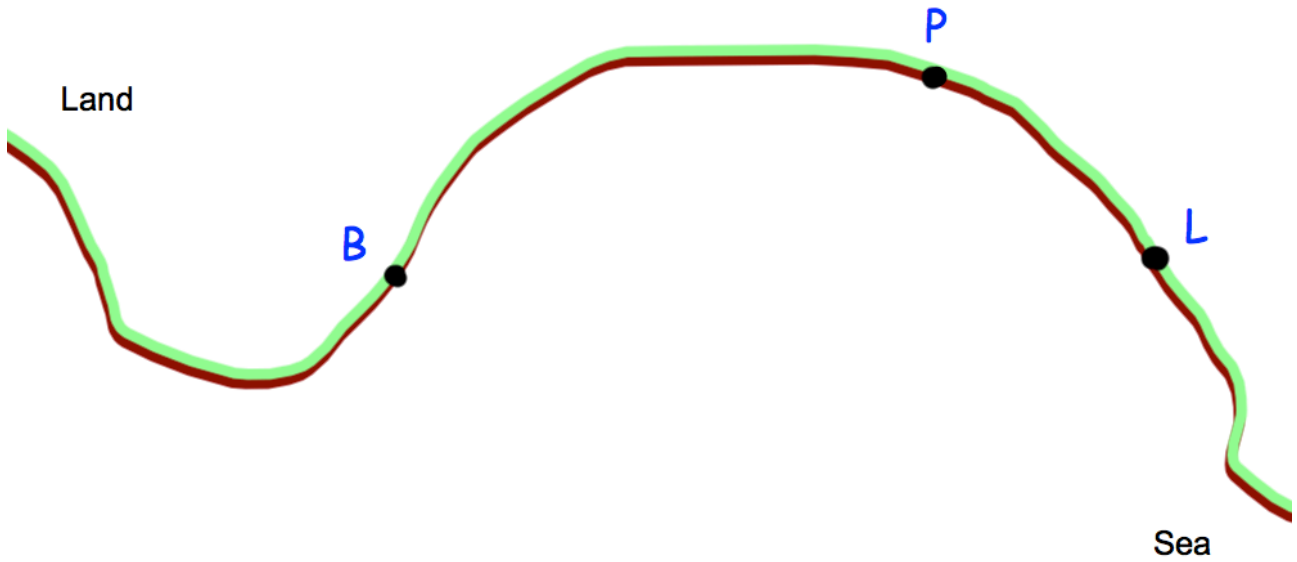

A yacht leaves the port, P, on a course that is an equal distance from PB and PL.

Using ruler and compasses only, construct the course on the diagram.  
You must show your construction arcs.

(2)

7. A shape has been made from joining a rectangle, trapezium and triangle.

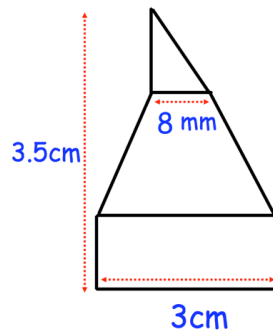

The height of the shape is 3.5cm.  
 The ratio of the height of the rectangle to the height of the trapezium to the height of the triangle is 2:3:2.  
 Calculate the area of the shape.

.....cm<sup>2</sup>  
**(3)**

- 8.

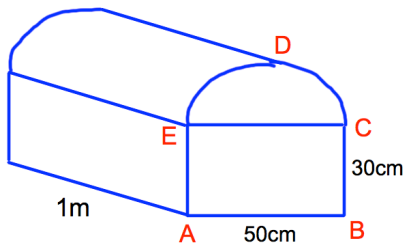

Shown above is a prism that is 1 m long.  
 ABCDE is the cross-section of the prism.  
 ABCE is a rectangle and CDE is a semi-circle.  
 Calculate the volume of the prism.  
 Give your answer correct to 1 decimal place.

..... cm<sup>3</sup>  
**(4)**

9. The swimming pool in a leisure centre is shown below.

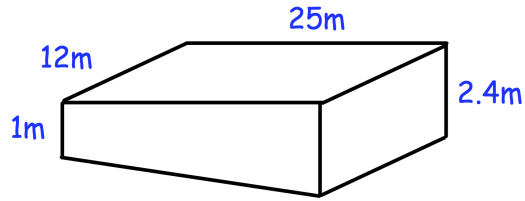

The length of the swimming pool is 25m and the width is 12m.  
 The depth of the shallow end is 1m and the depth of the deep end is 2.4m.  
 Given  $1\text{m}^3 = 1000$  litres  
 Work out how much water, in litres, the swimming pool holds.

..... litres  
**(4)**

10. The mass of books on a shelf are recorded in a stem and leaf diagram.

Key: 0 | 1 means 0.1kg

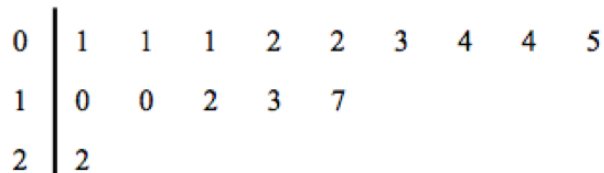

(a) Write down the median.

.....  
**(1)**

(b) Work out the total mass of books on the shelf.

.....  
**(2)**

A book weighing 1.8kg is added to the shelf.

Peter says the median will remain the same.

(c) Is Peter correct? Explain your answer.

.....  
**(2)**

---

11. A teacher surveys 64 children on how they travelled to school.

20 of the students were in Year 7.

The teacher surveyed 30% more students in Year 9 than in Year 7.

The rest of the students surveyed were in Year 11.

75% of the students in Year 7 walked to school.

8 more students in Year 9 walked to school than did not walk.

Out of students surveyed, more Year 11 students walked to school than Year 9 students.

One of these students is picked at random

Write down the probability that the student chosen will walk to school.

.....  
**(4)**

12. Barry won £420 in a competition.

The pie chart shows how he shared the money with his brother, Nick, and sister, Helen.

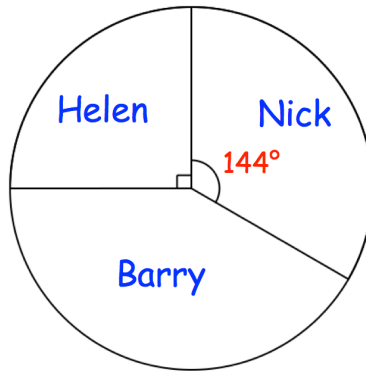

With the money Barry kept for himself, he spent some and invested some, in the ratio 5:2.

How much money did Barry invest?

.....  
(4)

13. The frequency polygon shows the length of 330 river eels.

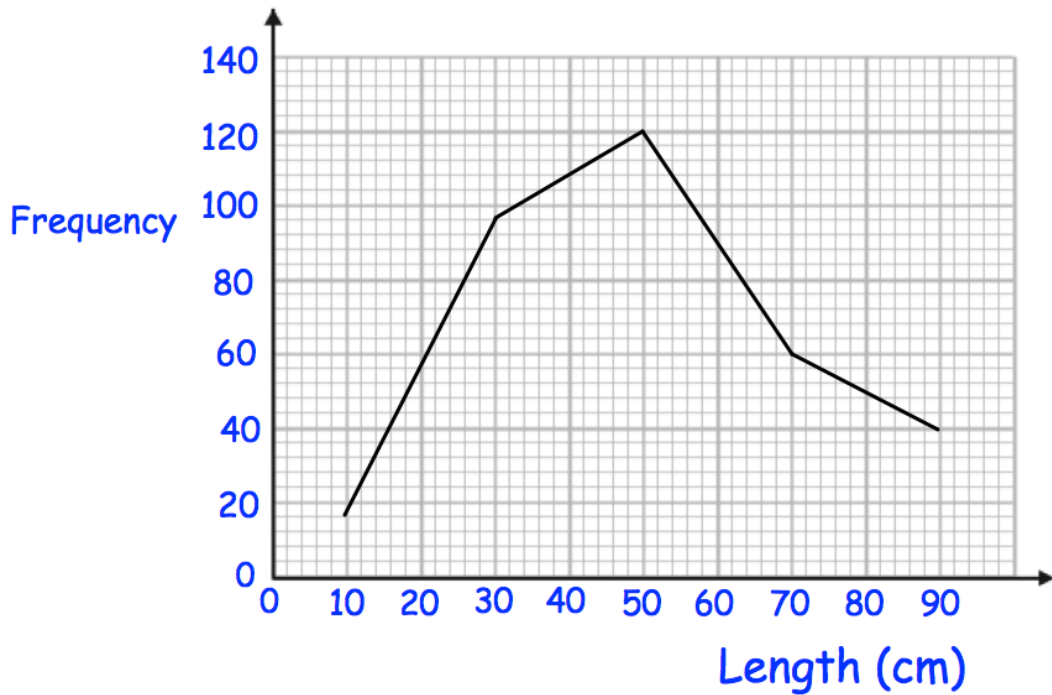

The table shows the lengths of 330 sea eels.

Length (cm)	Frequency
$0 < t \leq 20$	12
$20 < t \leq 40$	60
$40 < t \leq 60$	108
$60 < t \leq 80$	90
$80 < t \leq 100$	60

(a) Draw a frequency polygon to show this information on the diagram above. (2)

(b) Calculate an estimate of the mean length of a sea eel.

.....cm  
(3)

14. Trains to Portadown leave a train station every 28 minutes.  
Trains to Portrush leave a train station every 16 minutes

A train to Portadown and a train to Portrush both leave the train station at 8am.

When will a train to Portadown and a train to Portrush both leave the train station at the same time?

.....  
(3)

---

15. Simplify

$$\frac{10m^5n^4}{2m^2n}$$

.....  
(2)

16. Bethan owns 10 shops and 5 restaurants. She is going to visit three of her businesses and writes her list in order. The order will be:

shop, restaurant, shop  
or  
restaurant, shop, restaurant

How many different lists can Bethan write?

.....  
**(3)**

---

17.  $v = u + at$

- (a) Work out  $v$  when  $u = 23$ ,  $a = 4$  and  $t = 3$

.....  
**(2)**

- (b) Work out  $u$  when  $v = 30$ ,  $a = 2$  and  $t = 8$

.....  
**(2)**

- (c) Work out  $t$  when  $v = 40$ ,  $u = 12$  and  $a = 4$

.....  
**(2)**



18. Make  $m$  the subject of

$$w(m + n) = x(m - n)$$

.....  
**(3)**

---

19. On the grid, draw the graph of  $3x - 2y = 6$

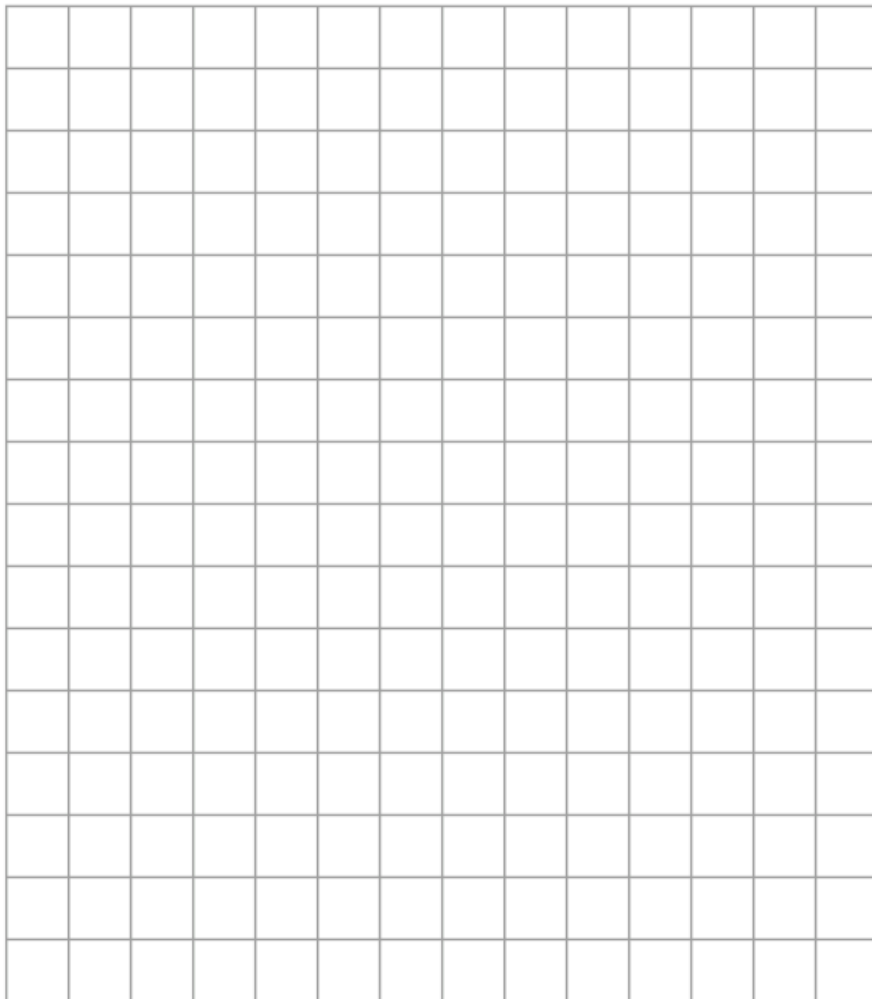

**(4)**

20. Four chairs and two tables cost £218.  
Six chairs and seven tables cost £587.

Find the total cost of buying twenty chairs and five tables.

£.....  
(4)

21. Here is a conversion graph to convert between GB pounds and Polish zloty.

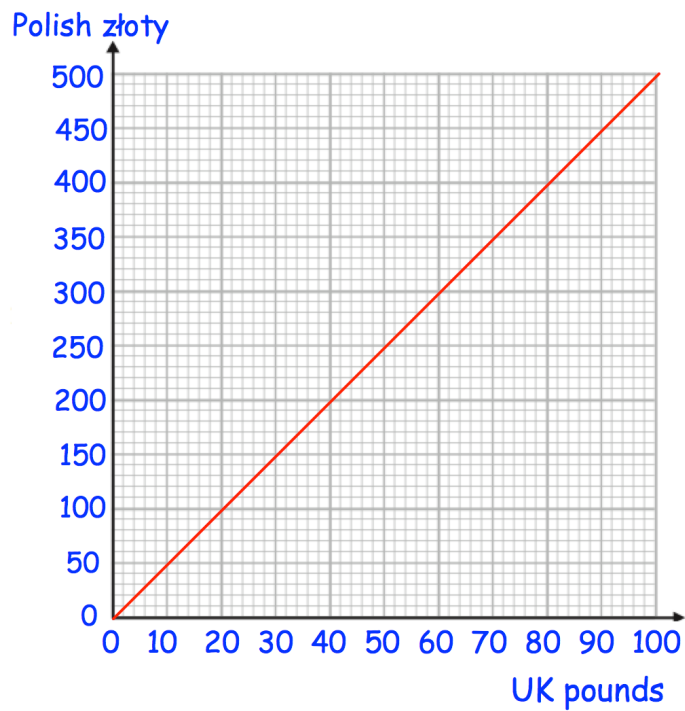

Jack has £400 and 1200 zloty.  
His hotel bill is 2000 zloty

He pays the bill with 1200 zloty and some of the pounds.

Work out how much money Jack has left.

£.....  
(4)

22. Nancy goes to the Post Office to exchange money.



Exchange Rates

£1 : \$1.31

£1 : €1.14

\*Commission Charged

Nancy changes \$759.80 and €342 into pounds sterling.  
The Post Office deducts their commission and gives Nancy £827.20  
What is the percentage commission?

.....%  
**(4)**

---

23. The ratio of the red cards to black cards in a deck is 3:10  
2 more red cards are added to the deck.  
The ratio of red cards to black cards is now 1:3

Work out the number of black cards in the deck.

.....  
**(3)**

24. The population of a country is increasing by 5% a year.  
How many years will it take the population of the country to double?

.....  
(3)

---

25. The length of each side of a regular hexagon is 4.7cm to 1 decimal place.  
Write the error interval for the perimeter, P

.....  
(3)

---

26. CE and FI are parallel lines.  
Angle EDH =  $50^\circ$   
Angle DGF =  $100^\circ$

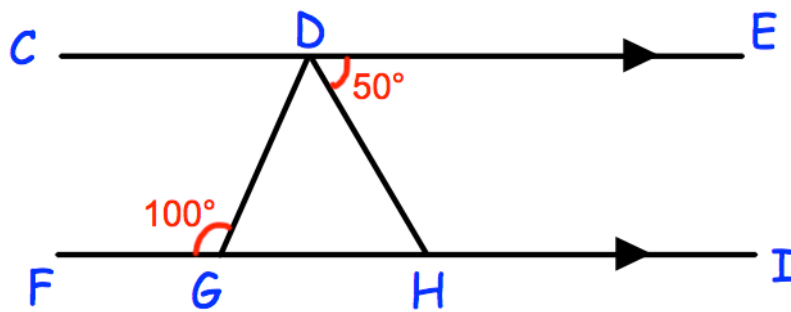

Show, giving reasons, that triangle DGH is isosceles.

(4)

27. The diagram shows the position of two towns, A and B.

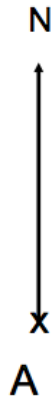

A rugby club, R, has bearing of  $110^\circ$  from town A.  
The rugby club, R, has bearing of  $245^\circ$  from town B.

In the space above, show the position of the rugby club R.  
Mark the position with a cross (x) and label it R.

**(3)**

28. Shown below is an interior angle from a regular polygon.

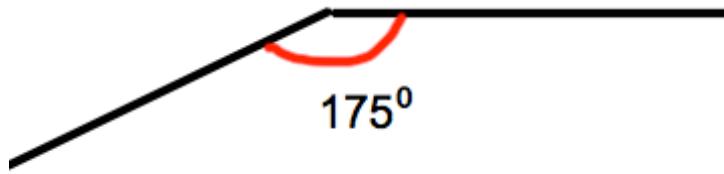

Calculate the number of sides the polygon has.

.....  
(2)

---

29. A circular wheel has a diameter of 30cm.  
The wheel rolls a distance of 60m.

Calculate the number of complete revolutions completed.

.....  
(4)

30. Write the numbers below in the form  $2^n$

(a) 4

.....  
**(1)**

(b) 8

.....  
**(1)**

(c) 32

.....  
**(1)**

(d)  $\frac{1}{2}$

.....  
**(1)**

(e)  $\frac{1}{4}$

.....  
**(1)**

(f)  $\sqrt{2}$

.....  
**(1)**

(g)  $\sqrt[3]{8}$

.....  
**(2)**

31. There are 1500 people at an ice hockey match.  
The announcer says that this is exactly 30% more people than the previous match.  
Explain why the announcer is wrong.

**(3)**

---

32. Expand and simplify  $(x - 6)(x + 1)(x - 2)$

.....  
**(3)**



33. ABC and BCD are right angle triangles.

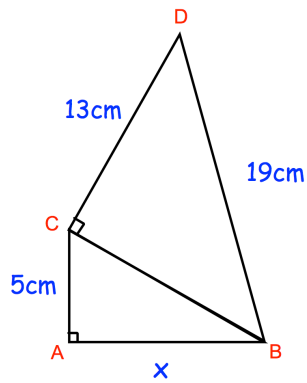

Find the length of AB

.....cm  
(4)

34. Draw the graph of  $y = (x - 1)(x - 2)$

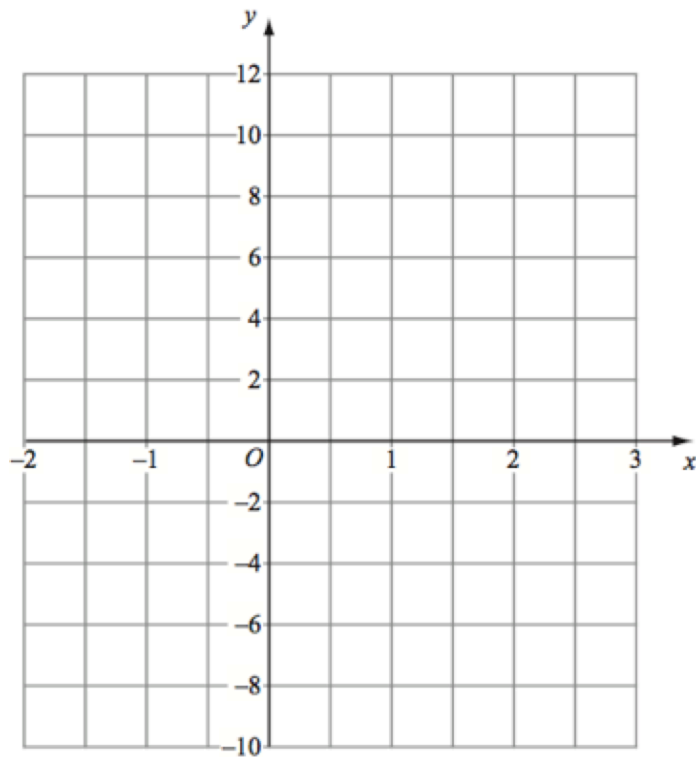

(3)

35. A rectangular lawn is 100m long and 45m wide.  
There are 3 circular ponds, with diameters of 20m, 10m and 5m respectively.

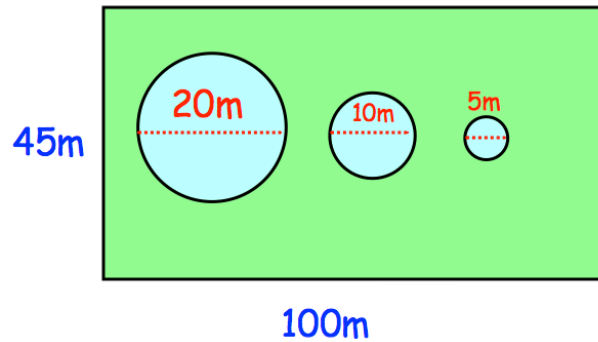

Mrs Jones wants to cover the lawn with grass seed.  
Each packet of grass seed covers  $50\text{m}^2$  and costs £1.49

How much will it cost Mrs Jones to cover the lawn with grass seed?

£.....  
(5)

36. The perimeter of this sector is 36cm

Perimeter = 36cm

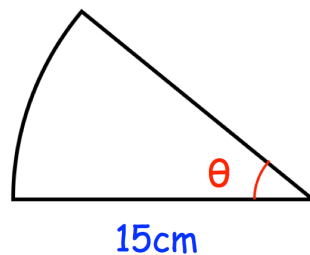

Find the size of the angle,  $\theta$

.....  
(3)

37. The areas of these two sectors are equal.

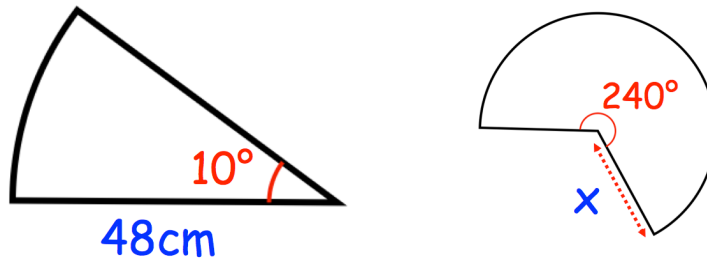

Find the length of  $x$

.....cm  
(4)

38. Two right-angled triangles are shown below.

PQ is 10cm.

QR is 3cm.

Angle QRS is  $65^\circ$

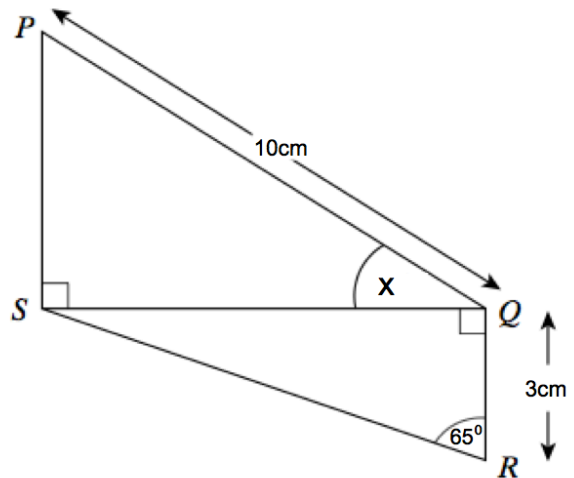

Calculate the size of angle PQS

.....  
(5)

39.

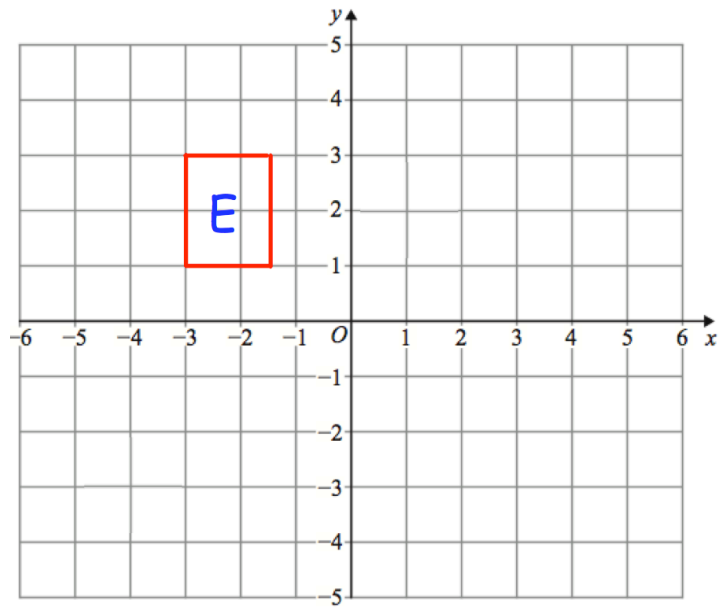

Translate E by  $\begin{pmatrix} 4.5 \\ -4 \end{pmatrix}$

(2)

40.

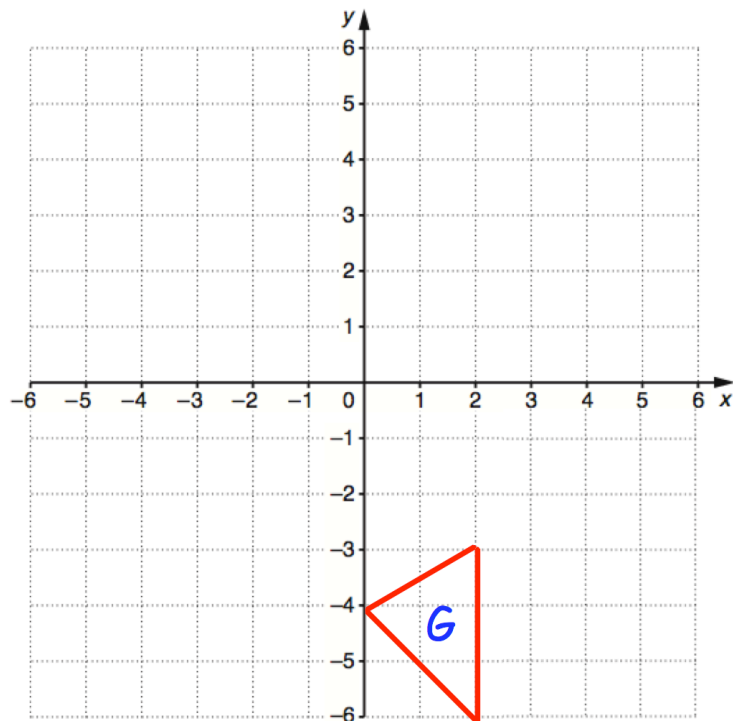

rotate  $90^\circ$  clockwise about  $(5, 0)$

(2)

41.

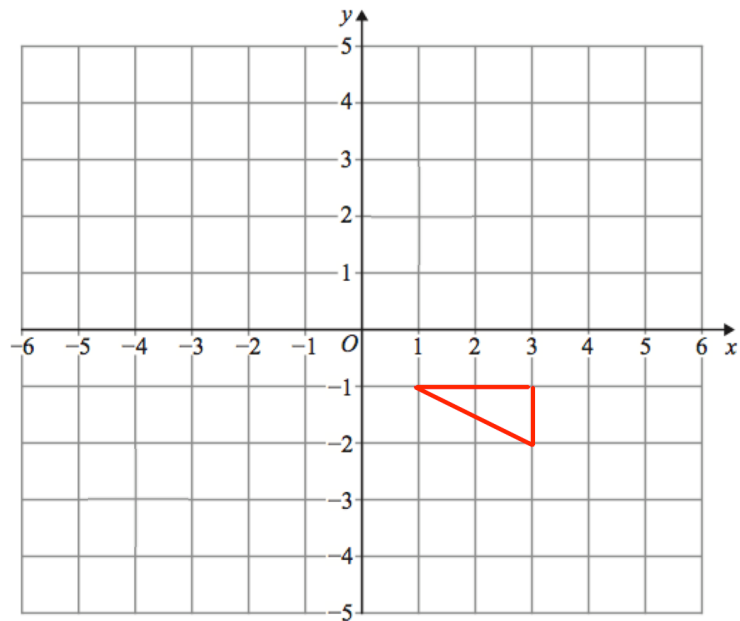

Enlarge by scale factor  $-2$  using  $(0, 0)$  as the centre of enlargement

(2)

42.

Reflect shape A in the line  $y = x$

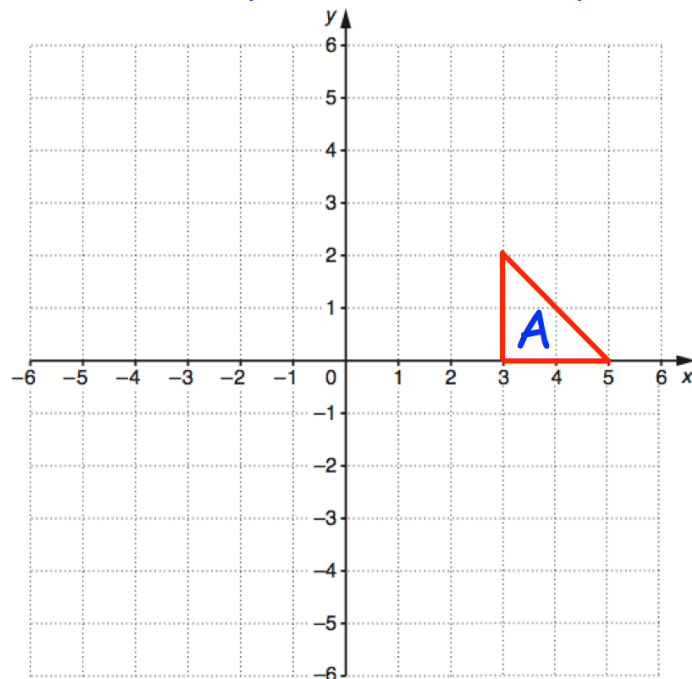

43.

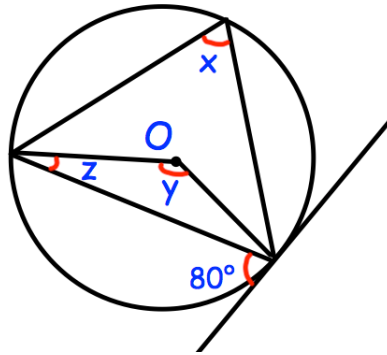

(a) Find the size of angle  $x$ .

.....<sup>o</sup>  
**(1)**

(b) Find the size of angle  $y$ .

.....<sup>o</sup>  
**(1)**

(c) Find the size of angle  $z$ .

.....<sup>o</sup>  
**(1)**

44. Teddy leaves home at 13:00  
He drives at an average speed of 60km/h for 2½ hours  
Teddy stops for 30 minutes.  
He then drives home at an average speed of 50km/h

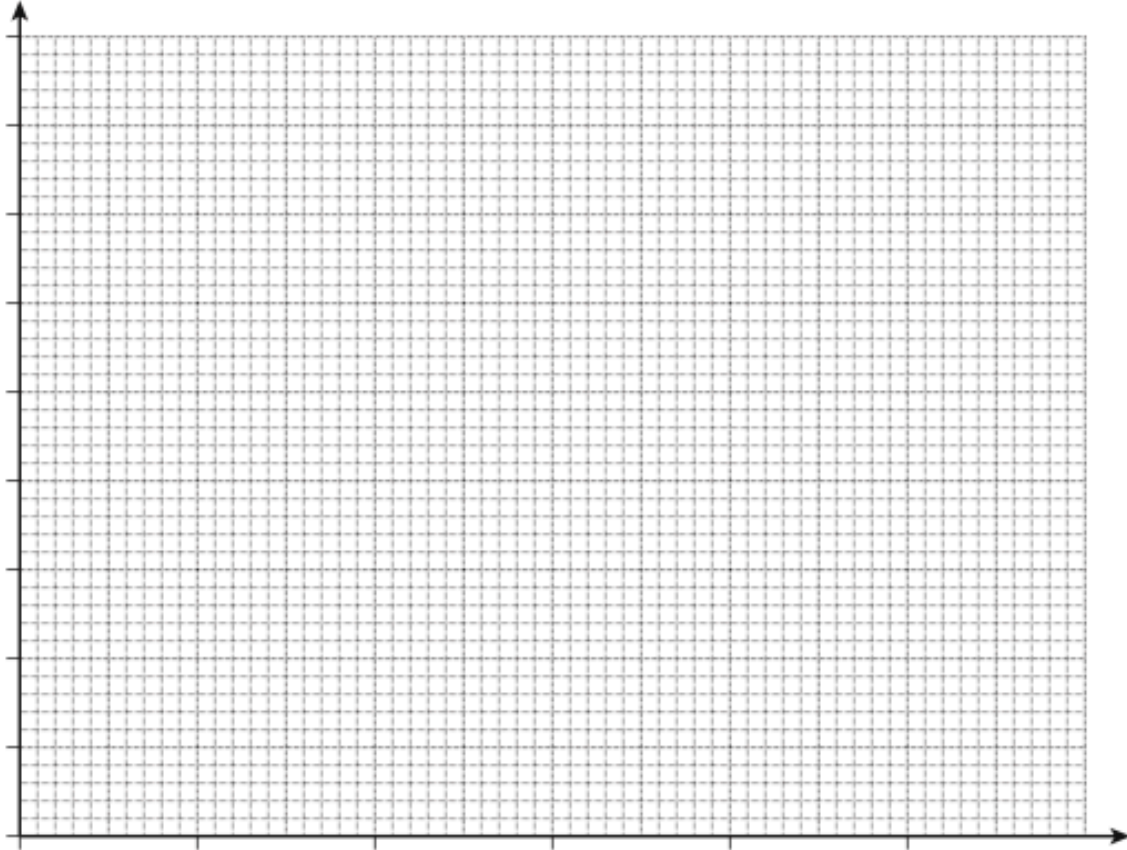

(a) Show this information on a distance-time graph.

**(4)**

(b) A film starts at 18:45

Does Teddy get home in time for the start?  
Explain your answer.

.....  
.....

**(1)**

45. Michael drives 143 miles from town A to town B in 2 hours 36 minutes.  
He then drives from town B to town C at the same speed and it takes 21 minutes.

How far did Michael drive in total?

.....miles  
**(4)**

- 
46. Material A has a density of  $5.8\text{g/cm}^3$ .  
Material B has a density of  $4.1\text{g/cm}^3$ .

377g of Material A and 1.64kg of Material B form Material C.

Work out the density of Material C.

..... $\text{g/cm}^3$   
**(4)**



47. The cumulative frequency diagram shows the distribution of speeds for 60 cars on a road.

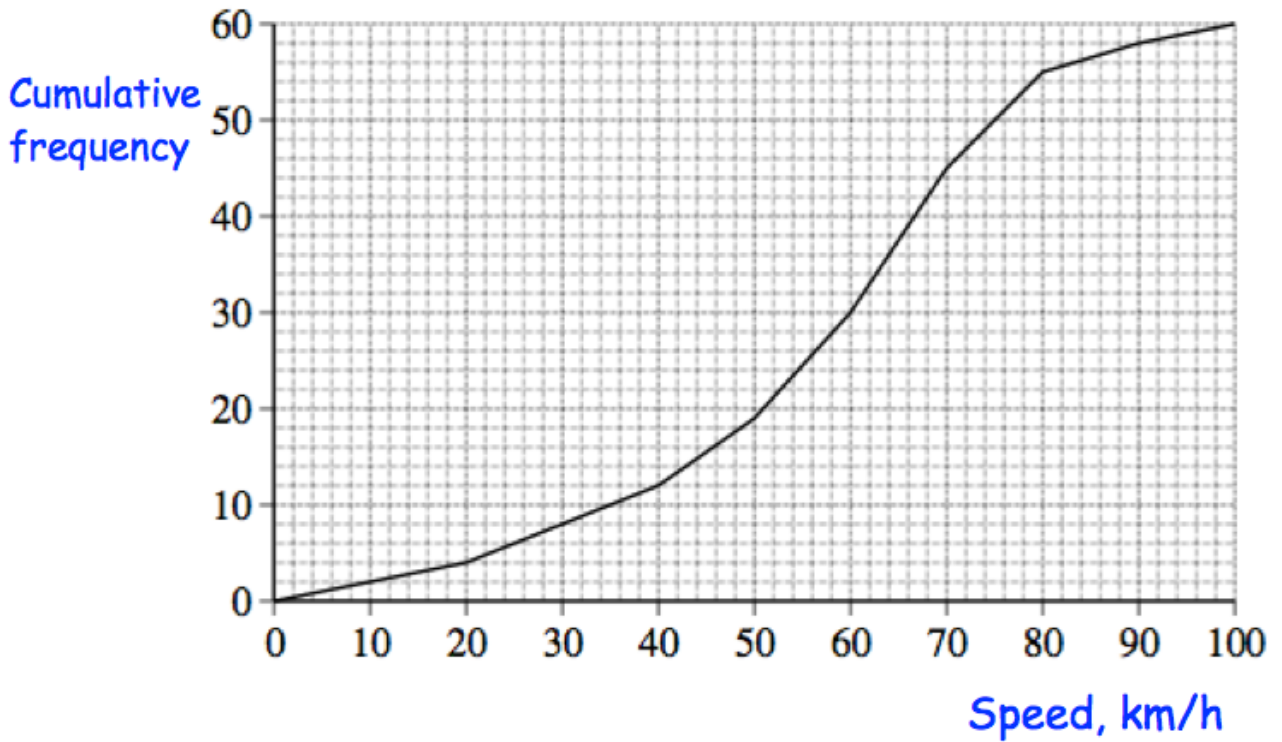

- (a) Estimate the median speed.

.....  
(1)

- (b) Estimate the interquartile range of the speeds.

.....  
(2)

The speed limit on the road is 85 km/h.

- (c) How many cars exceeded the speed limit?

.....  
(2)

48. The table shows the heights of the child at a school.

Height	Frequency
$120 < h \leq 130$	51
$130 < h \leq 140$	120
$140 < h \leq 150$	66
$150 < h \leq 160$	59
$160 < h \leq 170$	4

Work out an estimate for the mean height.

.....cm  
**(4)**

49. A college course consists of 8 weeks of teaching with a final exam at the end of the course

If a student fails the final exam, they have one opportunity to retake the exam.

The probability of a student passing the final exam is  $\frac{7}{8}$

The probability of a student passing the retake is  $\frac{2}{3}$

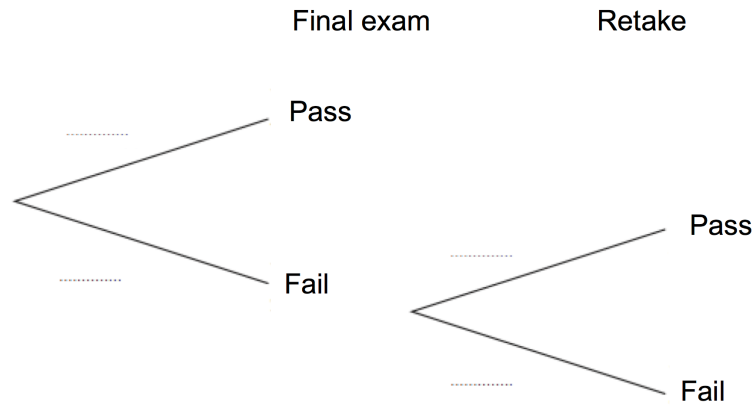

(a) Complete the tree diagram.

**(1)**

If a student passes the final exam or retake, they receive a certificate.

(b) Work out the probability that a student receives a certificate.

.....  
**(3)**

50. Darren wants to estimate how many grasshoppers live in a field.  
He catches and marks 24 grasshoppers.  
He then releases the grasshoppers.

The next day, Darren returns to the same field and captures 51 grasshoppers.  
7 of these have been marked.

Work out an estimate for the total number of grasshoppers in the field.

.....  
(3)

- 
51. The Venn diagram shows information about the cars in a car park.

$\xi$  = 150 cars in the car park

R = red cars

J = cars manufactured in Japan

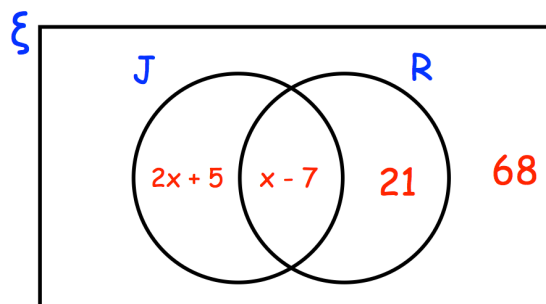

A car is chosen at random.

Work out the probability that it is red.

.....  
(4)

52. The histogram shows information about how far 150 children swam, when trying to get their swimming certificates.

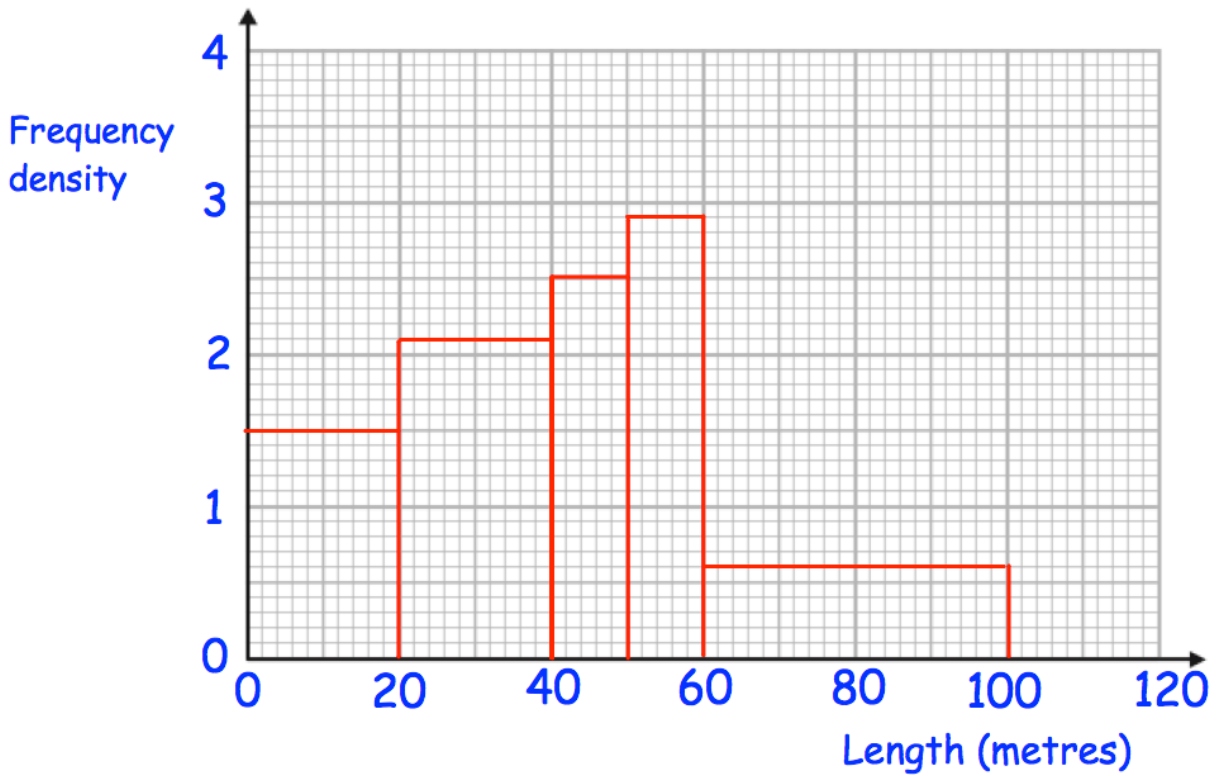

(a) Complete this frequency table.

Length, $l$ metres	Frequency
$0 < l \leq 20$	30
$20 < l \leq 40$	
$40 < l \leq 50$	25
$50 < l \leq 60$	
$60 < l \leq 100$	24

(2)

(b) 10% of the swimmers swam further than  $y$  metres.  
Calculate an estimate of  $y$ .

.....  
(2)

53. Two solid clay models of the Statue of Liberty are mathematically similar.



The smaller model has a height of 15cm.  
The larger model has a height of 20cm.

The smaller model has a mass of 108g.

Work out the mass of the larger model.

.....g  
**(3)**

- 
- 54.

$$w = aT$$

Given  $a = 15$  correct to 2 significant figures  
and  $w = 700$  correct to 2 significant figures  
Calculate the upper bound for  $T$

.....  
**(3)**

55. Factorise fully  $32y^3 + 24y^2$

.....  
(2)

---

56. (a) Factorise  $x^2 - x - 72$

.....  
(2)

(b) Factorise  $4x^2 + 12x - 7$

.....  
(2)

---

57. Solve  $\frac{x + 3}{4} = \frac{3}{x - 1}$

.....  
(3)

58. Solve  $x^2 - 6x - 20 = 0$

Give your answers to 1 decimal place.

.....  
**(3)**

---

59. Here are the  $n$ th terms of 4 sequences.

Sequence 1	$n$ th term	$3n + 1$
Sequence 2	$n$ th term	$5n + 10$
Sequence 3	$n$ th term	$10n$
Sequence 4	$n$ th term	$5n - 1$

For each sequence state whether the numbers in the sequence are

- A Always multiples of 5
- S Sometimes multiples of 5
- N Never multiples of 5

Sequence 1 .....

Sequence 2 .....

Sequence 3 .....

Sequence 4 .....

**(4)**



60. Here are the first 5 terms of a quadratic sequence

4      10      18      28      40

Find an expression, in terms of  $n$ , for the  $n$ th term of this quadratic sequence.

.....  
(3)

61. Shown is a pentagon, with the size of each angle shown.

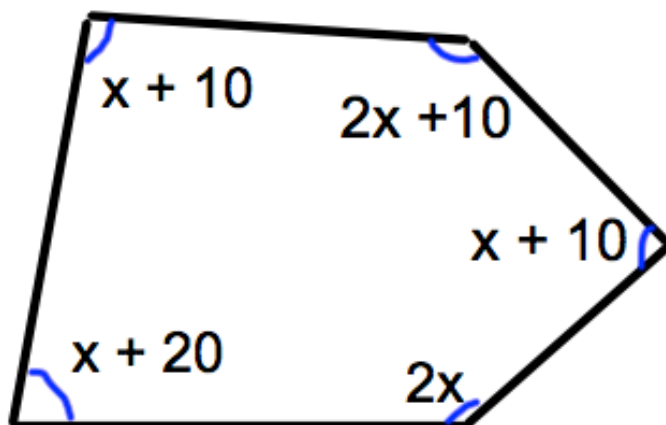

Find the size of the largest angle.

.....<sup>0</sup>  
(4)

62. (a) Solve the inequality  $4x + 6 \geq 2$

.....  
(2)

(b) Write down the inequality shown by the diagram.

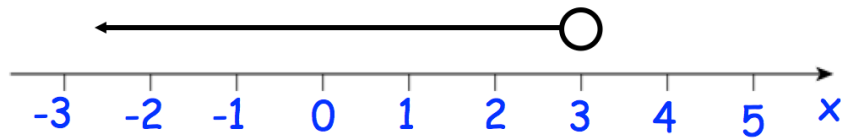

.....  
(1)

(c) Write down all the integers that satisfy both inequalities shown in part (a) and (b).

.....  
(1)

63.

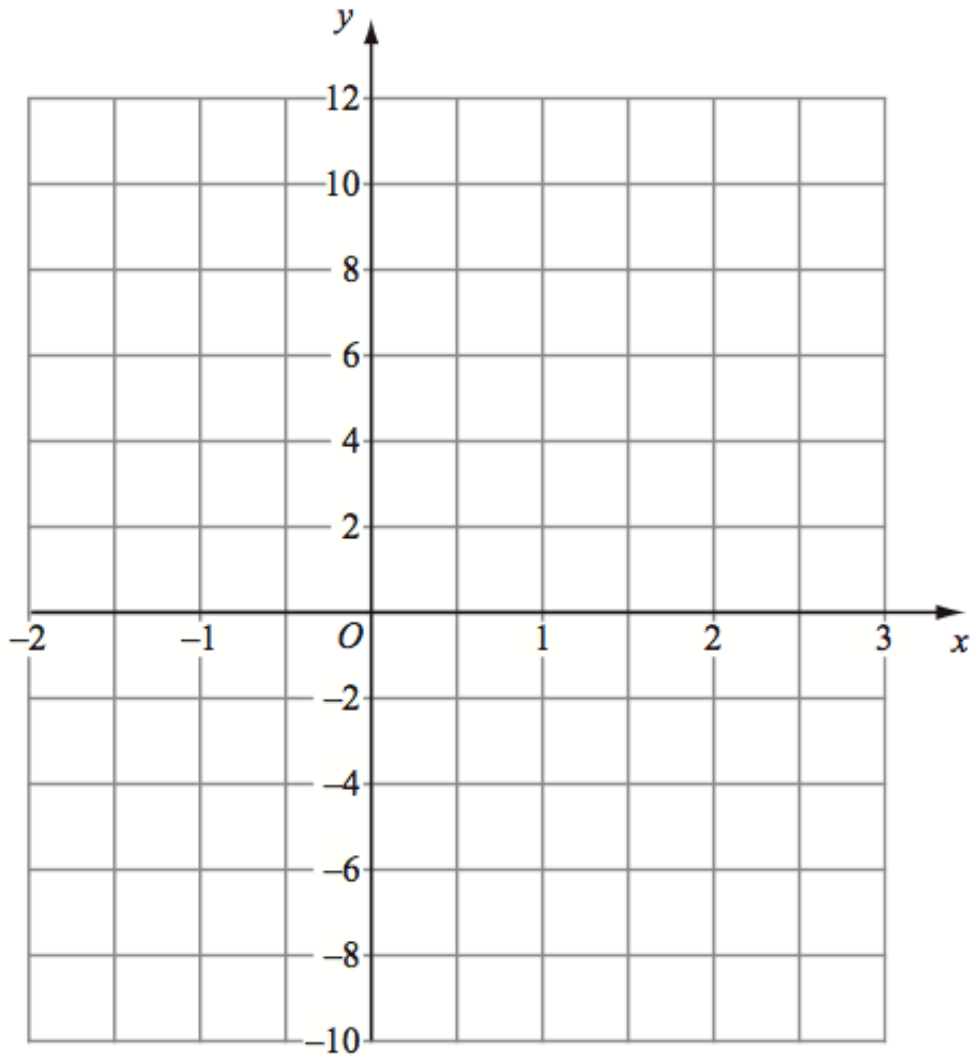

On the grid, label the region that satisfies all three of these inequalities

$$-1 < x < 2$$

$$y \leq 8$$

$$y \geq 4x - 4$$

(4)

64. Solve the inequality  $x^2 - 6x + 8 \geq 0$

(3)

65. The circle below has centre  $(0, 0)$ .  
The point  $(-15, 8)$  is a point on the circle.

Find the equation of the circle.

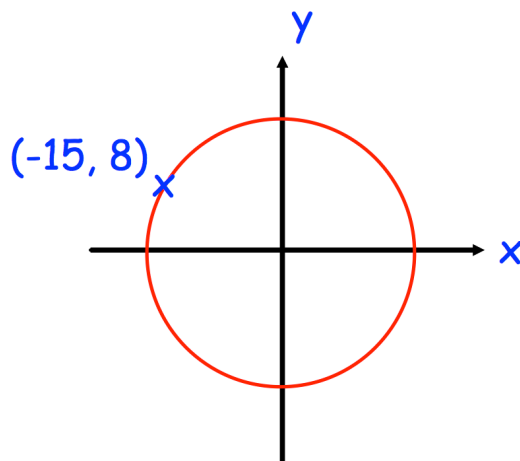

.....  
(3)

66.

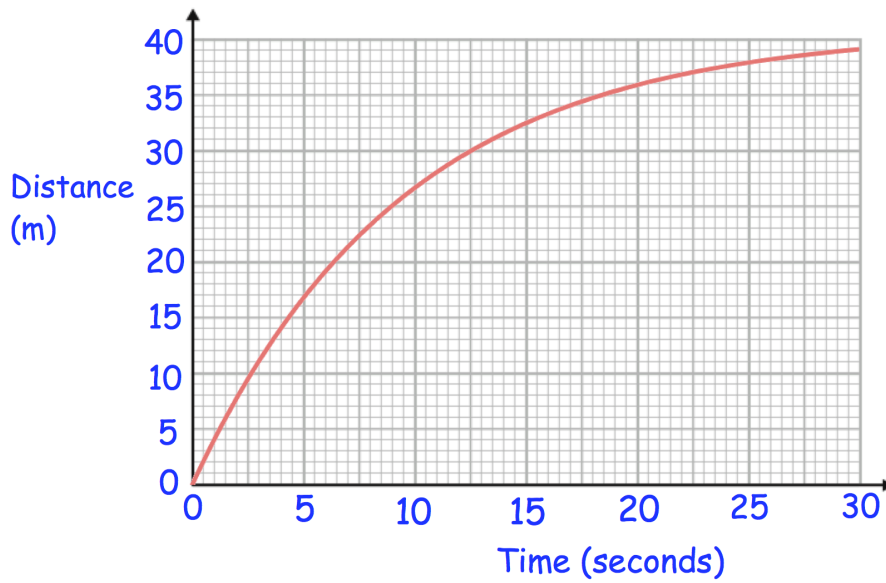

(a) Work out the speed at  $t = 5$  seconds

.....m/s  
(3)

(b) Work out the average speed between 15 and 30 seconds

.....m/s  
(3)

67. Solve

$$\frac{3}{x-2} + \frac{3}{x+2} = 2$$

.....  
(5)

68. The functions  $f(x)$ ,  $g(x)$  and  $h(x)$  are given by the following:

$$f(x) = x^2 - 3$$

$$g(x) = 2x + 1$$

$$h(x) = \frac{x}{2}$$

(a) Find  $fg(x)$

.....  
(2)

(b) Find  $gh(x)$

.....  
(2)

(c) Find  $h^{-1}(x)$

.....  
(2)

---

69. Sketch the graph of  $y = \sin(x)$  for  $0^\circ \leq x \leq 360^\circ$

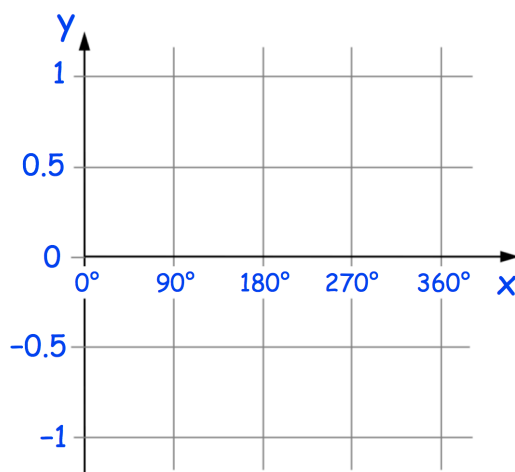

(2)

70.

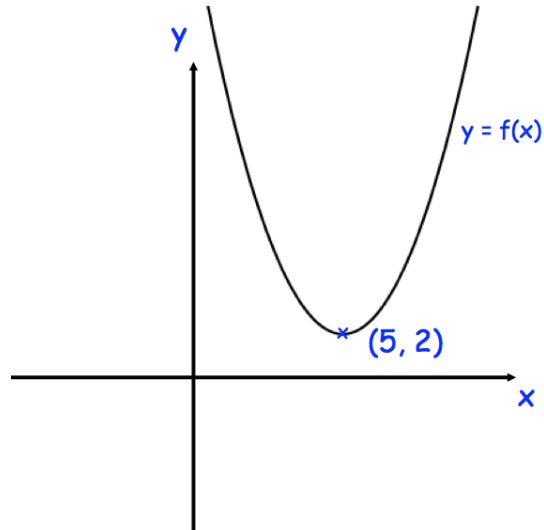

Shown is the curve with equation  $y = f(x)$

The coordinates of the minimum point of the curve are  $(5, 2)$ .

Write down the coordinates of the minimum point of the curve with equation

(a)  $y = f(x) - 4$

(....., .....)  
**(1)**

(b)  $y = f(x - 2)$

(....., .....)  
**(1)**

(c)  $y = f(-x)$

(....., .....)  
**(1)**

71. Write  $x^2 + 12x - 1$  in the form  $(x + a)^2 + b$ , where  $a$  and  $b$  are constants.

.....  
(3)

---

72. (a) Show that the equation  $3x - x^3 = -11$  has a solution between  $x = 2$  and  $x = 3$

(2)

(b) Show that the equation  $3x - x^3 = -11$  can be rearranged to give

$$x = \sqrt[3]{3x + 11}$$

(2)

(c) Starting with  $x_0 = 3$ , use the iteration formula  $x_{n+1} = \sqrt[3]{3x_n + 11}$  three times to find an estimate for the solution of  $3x - x^3 = -11$

(3)



73. Complete the table of values for  $y = \frac{5}{x}$

$x$	0.5	1	2	4	8	10
$y$						

(2)

(b) On the grid, draw the graph of  $y = \frac{5}{x}$  for  $0.5 \leq x \leq 10$

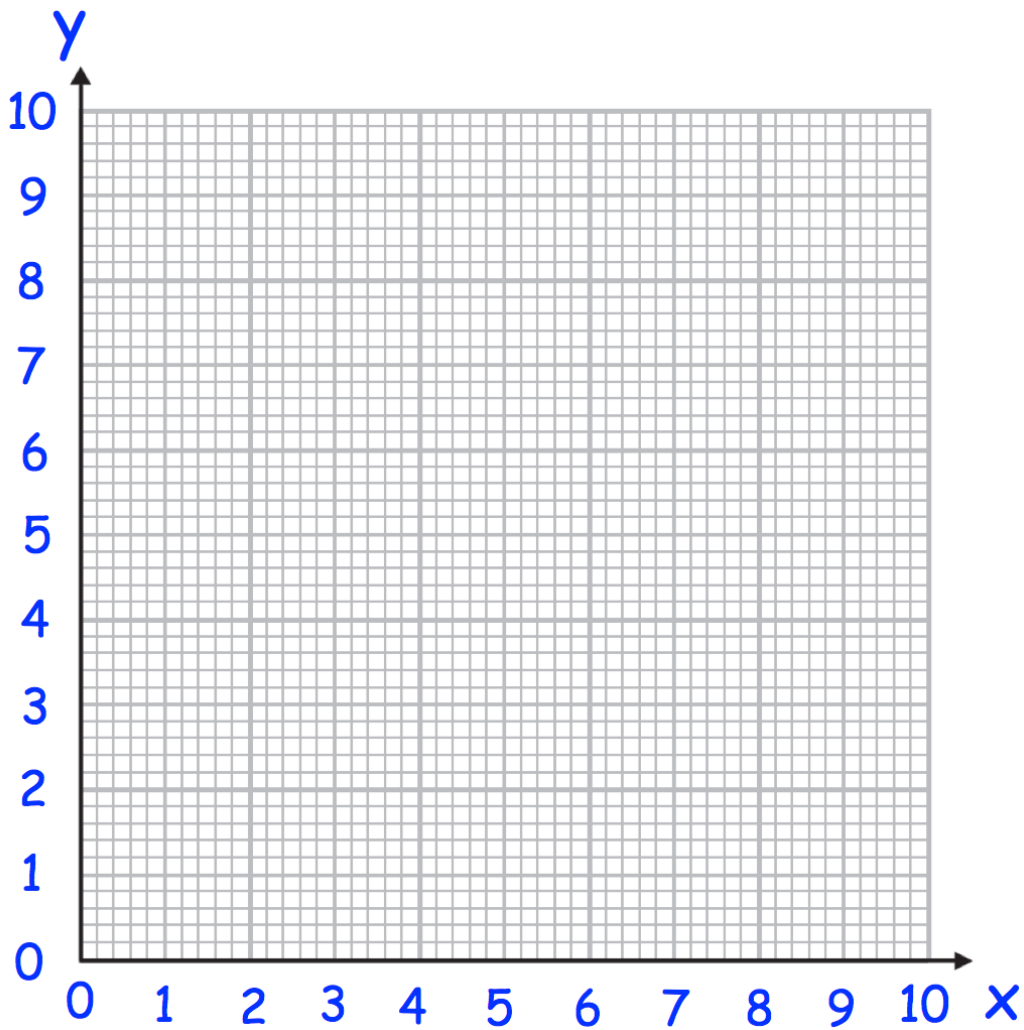

(2)

74.

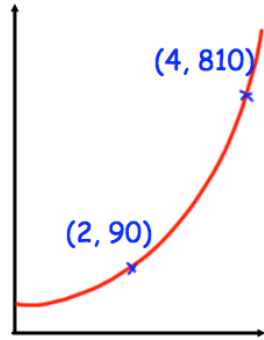

The sketch shows a curve with equation  $y = ab^x$  where  $a$  and  $b$  are constants and  $b > 0$

The curve passes through the points  $(2, 90)$  and  $(4, 810)$

Calculate the value of  $a$  and  $b$

$a = \dots\dots\dots$

$b = \dots\dots\dots$

**(3)**

75. Use algebra to prove

$$0.2\dot{8} = \frac{13}{45}$$

**(3)**

76. A shed has dimensions, in metres, of

$$\text{height} = \sqrt{5}, \text{ width} = \sqrt{6} \text{ and length} = \frac{9}{\sqrt{2}}$$

Find the volume of the shed.

Give your answer in the form  $a\sqrt{15}$ , where  $a$  is an integer.

.....m<sup>3</sup>  
**(3)**

---

77. Here is a circle, centre  $O$ , and the tangent to the circle at the point  $(2, -4)$ .

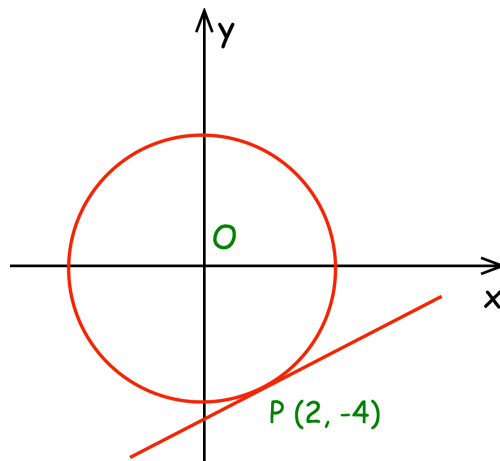

Find the equation of the tangent at the point  $P$ .

.....  
**(3)**

78.

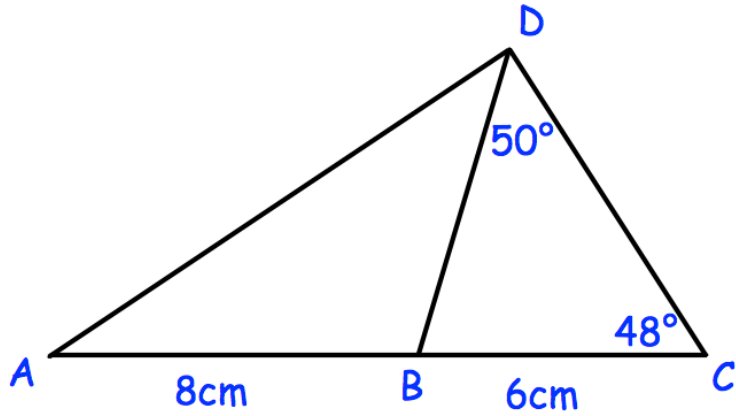

ACD is a triangle and B is a point on AC.  
AB = 8cm and BC is 6cm.  
Angle BCD =  $48^\circ$  and angle BDC =  $50^\circ$ .

(a) Find the length of BD.

.....cm  
(3)

(b) Find the length of AD.

.....cm  
(3)

(c) Find the area of triangle ABD.

.....cm<sup>2</sup>  
(3)

79. A cylinder is placed on a table.  
The cylinder has a weight of 400N and has a diameter of 10cm.

Work out the pressure on the table in newtons/cm<sup>2</sup>

.....N/cm<sup>2</sup>  
**(3)**

---

80.

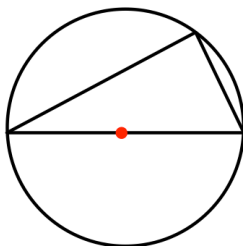

Prove that the angle in a semi-circle is always 90°

**(3)**

81. The mass of a paperweight is  $m$  grams.  
The length of the paperweight is  $L$  centimetres.  
 $m$  is directly proportional to the cube of  $L$ .

$$m = 4968 \text{ when } L = 12$$

- (a) Work out an equation connecting  $m$  and  $L$

.....  
**(3)**

- (b) Work out the mass of a paperweight with a length of 4 centimetres

.....  
**(2)**

82. A straight line passes through the points  $A(1, 4)$  and  $B(5, 16)$ .

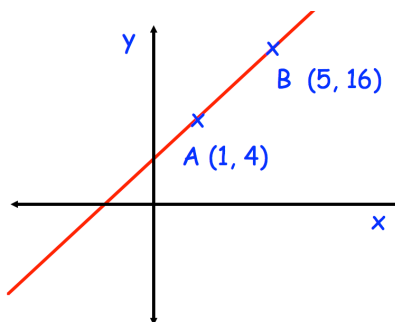

- (a) Find the equation of the line parallel to  $AB$  that passes through  $(1, 7)$

.....  
**(2)**

- (b) Find the equation of the line perpendicular to  $AB$  that passes through the midpoint of  $AB$

.....  
**(3)**

83.

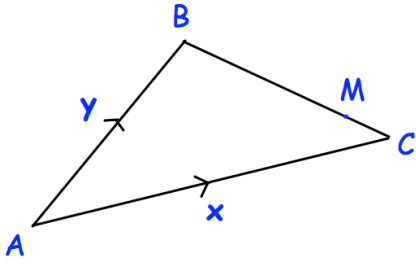

ABC is a triangle.

M lies on BC such that  $BM = \frac{4}{5} BC$

Express these vectors in terms of  $\mathbf{x}$  and  $\mathbf{y}$

(a)  $\overrightarrow{BC}$

.....  
(1)

(b)  $\overrightarrow{BM}$

.....  
(1)

(c)  $\overrightarrow{AM}$

.....  
(1)

84. Shown below is a rectangular based pyramid.  
The apex E is directly over the centre of the base.

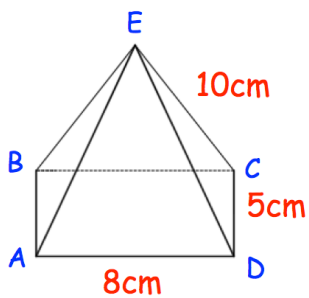

AD = 8cm  
CD = 5cm  
CE = 10cm

- (a) Calculate the height of the pyramid

.....cm  
(4)

- (b) Calculate angle between the face ABE and the base ABCD

.....°  
(3)



85. This sphere and cone have the same volume.

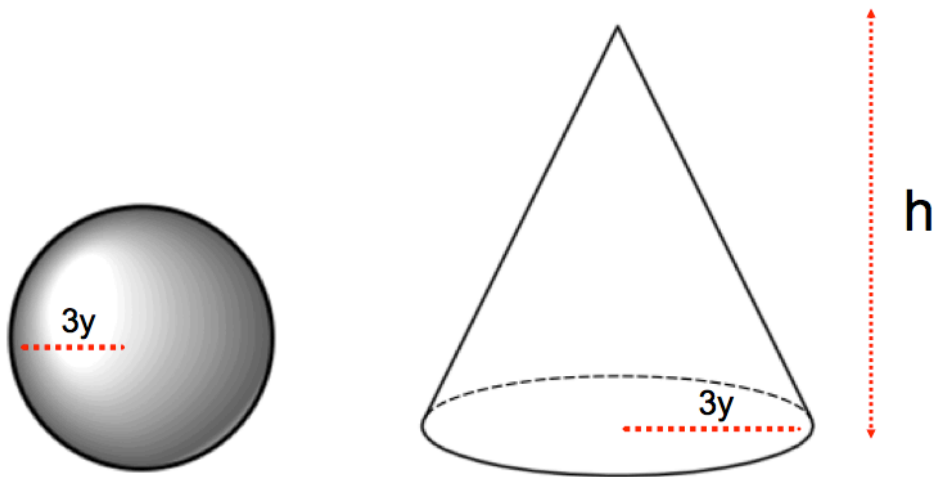

Find an expression for  $h$  in terms of  $y$ .

$h = \dots\dots\dots$   
(5)

86. There are 50 students in Year 11.  
Each student studies one language.

	French	German
Female	13	15
Male	5	17

Two of these students are selected at random.

Calculate the probability that the two chosen students study the same language.

.....  
(4)

- 
87. In the diagram, the lines CE and DF intersect at G.  
CD and FE are parallel and  $CD = FE$ .

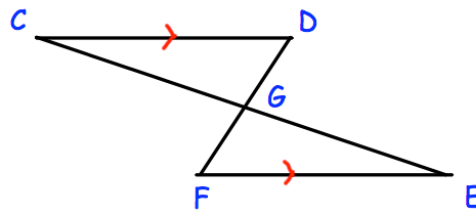

Prove that triangles CDG and EFG are congruent.

(3)

88. The first five terms of a linear sequence are 5, 11, 17, 23, 29 ...

(a) Find the  $n$ th term of the sequence

.....  
(2)

A new sequence is generated by squaring each term of the linear sequence and then adding 5.

(b) Prove that all terms in the new sequence are divisible by 6.

(4)

---

89. Below is a right angled triangle.

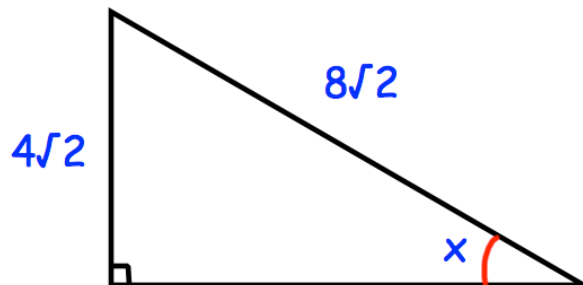

Show that angle  $x = 30^\circ$   
Include all your working.

(2)

90. On 1st March 2001, the ratio of Freddie's age to his mother's age was 1:11  
On 1st March 2018, the ratio of Freddie's age to his mother's age was 2:5

Write the ratio of Freddie's age to his mother's age on 1st March 2030

.....  
(4)

91.

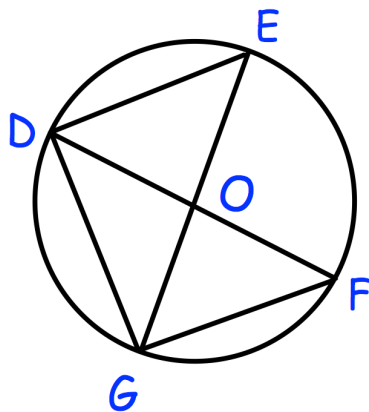

O is the centre of the circle.  
DOF and EOG are diameters of the circle shown.  
Prove triangles DEG and DFG are congruent.

(3)

92. Here is a speed-time graph for a remote-controlled car



- (a) Work out an estimate for the distance travelled over the first 12 seconds of the journey.  
Use 4 strips of equal width.

.....m  
(4)

- (b) Is your answer to (a) an overestimate or an underestimate of the actual distance travelled?  
Explain your answer

.....  
.....  
(1)

93. Shown is triangle ABC

ABC is rotated  $180^\circ$  about  $(-1, 2)$  and then translated by the vector  $\begin{pmatrix} 2 \\ -4 \end{pmatrix}$

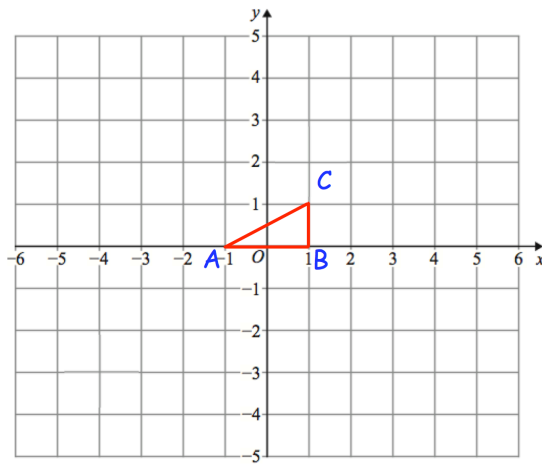

Write down the coordinate of the invariant point.

.....  
**(3)**

94. Solve the equations

$$y = x^2 - 5$$

$$y = 2x - 2$$

.....  
(5)